



**BMI USA LEAD FREE BRASS BALL VALVES
PRICE LIST**



**BBV
21-1**

February 1, 2021

FULLPORT "SWEAT" BRASS BALL VALVES

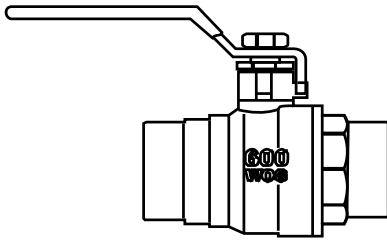

600CWP 150SWP				
BMI#	Size	Packing	Barcode	\$
13204	1/2	10/100	777701132049	29.75
13205	3/4	10/80	777701132056	46.01
13206	1	8/48	777701132063	74.66
13207	1 1/4	4/24	777701132070	114.72
13208	1 1/2	2/16	777701132087	159.49
13209	2	1/12	777701132094	241.69

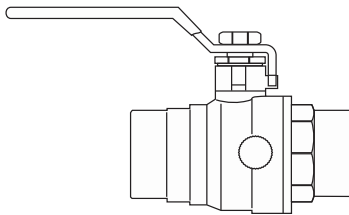

400CWP 100 SWP				
13210	2 1/2	1/1	777701132100	522.66
13211	3	1/1	777701132117	682.15
13212	4	1/1	777701132124	1 294.36

SOLDER END BALL VALVES WITH DRAIN				
13224	1/2	10/100	777701132247	31.29
13225	3/4	10/80	777701132254	47.54
13226	1	6/36	777701132261	76.19

FULLPORT "THREADED" BRASS BALL VALVES

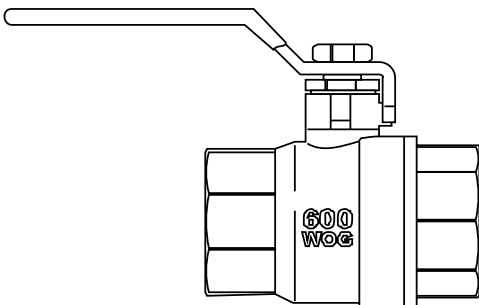

600CWP 150SWP				
BMI#	Size	Packing	Barcode	\$
13102	1/4	10/120	777701131028	24.66
13103	3/8	10/120	777701131035	24.66
13104	1/2	10/100	777701131042	31.59
13105	3/4	10/80	777701131059	47.38
13106	1	8/48	777701131066	78.76
13107	1 1/4	4/36	777701131073	119.71
13108	1 1/2	2/24	777701131080	165.01
13109	2	1/12	777701131097	230.04

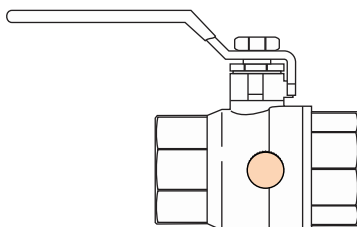

400CWP 100 SWP				
13110	2 1/2	2/4	777701131103	552.10
13111	3	1/6	777701131110	733.68
13112	4	1/1	777701131127	1 361.84

BALL VALVES WITH DRAIN				
13124	1/2	10/100	777701131240	35.09
13125	3/4	6/60	777701131257	50.43
13126	1	8/48	777701131264	80.36



FULLPORT PRESS-FIT BRASS BALL VALVES

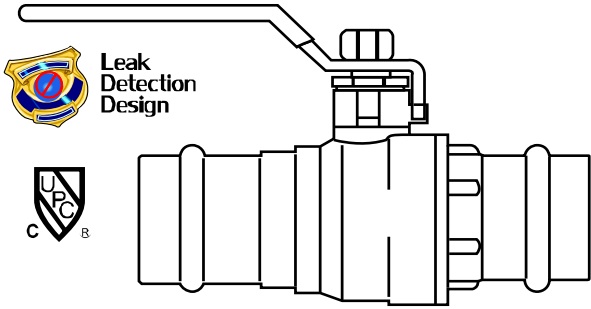

250PSI				
BMI#	Size	Packing	Barcode	\$
13514	1/2	10/50	777701135149	53.98
13515	3/4	10/30	777701135156	78.28
13516	1	5/20	777701135163	113.37
13517	1 1/4	4/12	777701135170	178.15
13518	1 1/2	3/6	777701135187	272.61
13519	2	2/6	777701135194	369.78
13520	2 1/2	1/4	777701135200	856.98
13521	3	1/3	777701135217	1 241.60
13522	4	1/2	777701135224	2 172.81

FULLPORT PRESS x PEX BRASS BALL VALVES

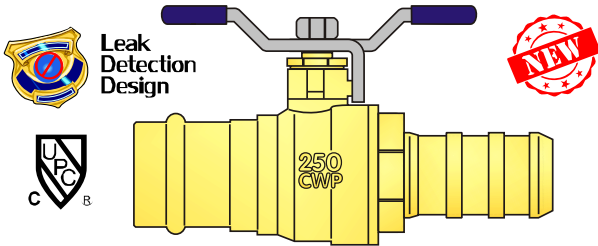

250PSI				
BMI#	Size	Packing	Barcode	\$
13574	1/2	10/100	777701135743	53.98
13575	3/4	10/100	777701135750	78.28
13576	1	5/50	777701135767	113.37

FULLPORT PRESS x COLD EXPANSION BRASS BALL VALVES

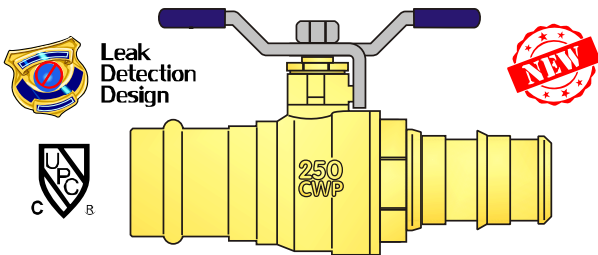

250PSI				
BMI#	Size	Packing	Barcode	\$
13584	1/2	10/100	777701135842	56.70
13585	3/4	10/100	777701135859	82.19
13586	1	5/50	777701135866	119.07

FULLPORT PRESS x IPS BRASS BALL VALVES

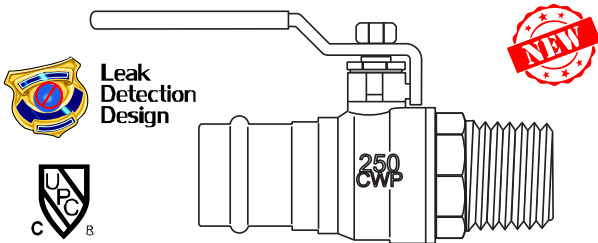

PRESS x MIPS				
BMI#	Size	Packing	Barcode	\$
13614	1/2	5/50	Coming Soon!	29.55
13615	3/4	5/30		49.35
13616	1	2/20		67.30

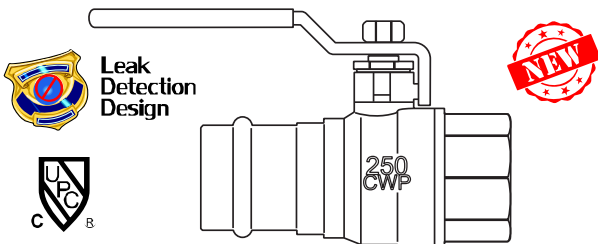

PRESS x FIPS				
BMI#	Size	Packing	Barcode	\$
13604	1/2	5/50	Coming Soon!	29.26
13605	3/4	5/30		48.86
13606	1	2/20		66.65

All taxes extra
All prices in U.S. dollars



PEX BRASS BALL VALVES

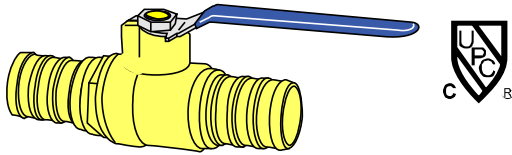

BLUE OR RED STRAIGHT HANDLES				
Blue	Red	Size	Packing	\$
13354	13454	1/2	10/100	19.57
13355	13455	3/4	10/100	27.12
13356	13456	1	6/60	46.44

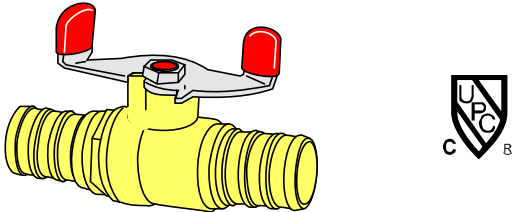

BLUE OR RED BUTTERFLY HANDLES				
Blue	Red	Size	Packing	\$
13364	13464	1/2	10/100	20.12
13365	13465	3/4	10/100	27.79
13366	13466	1	6/60	47.73

PEX BRASS BALL VALVES WITH DRAIN

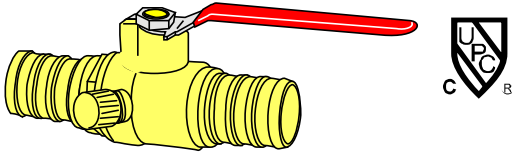

BLUE OR RED STRAIGHT HANDLES				
Blue	Red	Size	Packing	\$
13374	13474	1/2	10/100	22.27
13375	13475	3/4	10/100	30.49
13376	13476	1	6/60	51.96

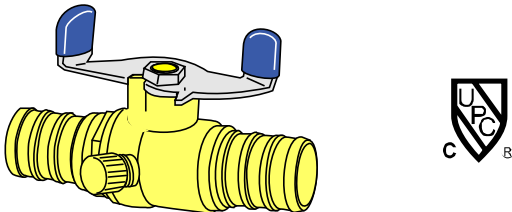

BLUE OR RED BUTTERFLY HANDLES				
Blue	Red	Size	Packing	\$
13384	13484	1/2	10/100	22.89
13385	13485	3/4	10/100	31.16
13386	13486	1	5/100	53.37

PEX x C BRASS BALL VALVES

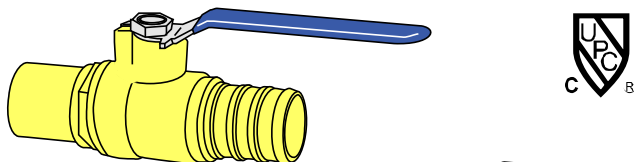

BMI#	Size	Packing	Barcode	\$
13324	1/2	10/100	777701133244	21.17
13325	3/4	10/100	777701133251	29.14

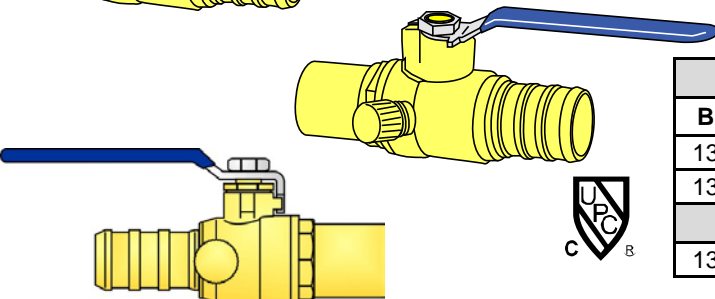

PEX x C BRASS BALL VALVES WITH DRAIN/COP				
BMI#	Size	Packing	Barcode	\$
13334	1/2	10/100	777701133343	28.59
13335	3/4	10/100	777701133350	35.76
PEX x C BRASS BALL VALVES WITH DRAIN/PEX				
13344	1/2	10/100	777701133442	28.59



FULLPORT COMPRESSION X COMPRESSION BALL VALVES

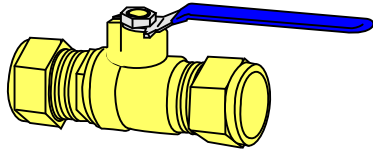

BMI#	Size	Packing	Barcode	\$
13554	1/2	10/100	777701135545	37.72
13555	3/4	10/100	777701135552	59.81
13556	1	10/60	777701135569	83.73

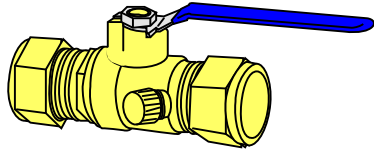

WITH DRAIN				
13564	1/2	10/100	777701135644	40.49
13565	3/4	10/100	777701135651	65.03

COLD EXPANSION BRASS BALL VALVES

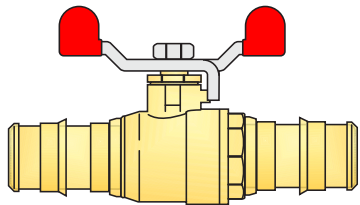

BMI#	Size	Packing	Barcode	\$
13954	1/2	10/100	777701139543	27.66
13955	3/4	10/100	777701139550	41.18
13956	1	2/64	777701139567	71.04

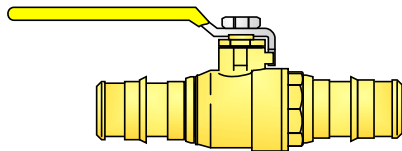

BMI#	Size	Packing	Barcode	\$
13854	1/2	10/100	777701138546	26.99
13855	3/4	10/100	777701138553	40.18
13856	1	8/100	777701138560	69.31
13857	1 1/4	4/50	777701138577	101.83
13858	1 1/2	5/50	777701138584	153.36
13859	2	5/25	777701138591	269.91

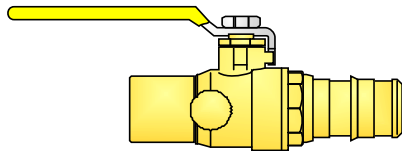

C X EXP. WITH DRAIN				
13874	1/2	10/100	777701138744	24.54
13875	3/4	10/100	777701138751	37.72



HANDLES AND STEM EXTENSIONS FOR BALL VALVES

These items are sold in multiples of inner pack quantities only. Minimum quantity is equal to one inner pack.

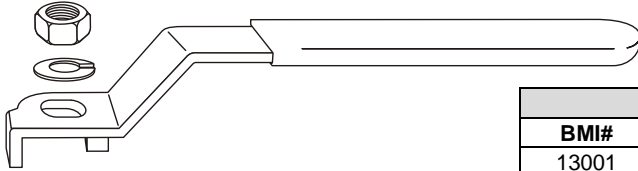

STAINLESS STEEL HANDLES					
BMI#	Size	Min. Qty	Packing	Barcode	\$
13001	1/4" to 1/2"	5	5/50	777701130014	4.67
13002	3/4" to 1"	5	5/30	777701130021	8.37
13003	1 1/4" to 2"	2	2/20	777701130038	13.98

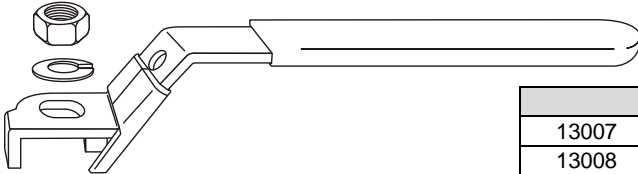

STAINLESS STEEL LOCK HANDLES					
BMI#	Size	Min. Qty	Packing	Barcode	\$
13007	1/4" to 1/2"	5	5/50	777701130076	6.56
13008	3/4" to 1"	5	5/30	777701130083	11.20
13009	1 1/4" to 2"	2	2/20	777701130090	14.91

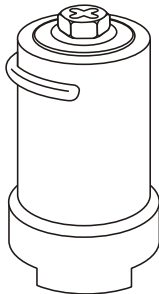

STEEL LOCK HANDLES					
BMI#	Size	Min. Qty	Packing	Barcode	\$
13004	1/4" to 1/2"	5	5/50	777701130045	5.21
13005	3/4" to 1"	5	5/30	777701130052	5.61
13006	1 1/4" to 2"	2	2/20	777701130069	6.56

BRASS STEM EXTENSIONS					
BMI#	Size	Min. Qty	Packing	Barcode	\$
13010	1/4" to 1/2"	5	5/50	777701130106	21.46
13011	3/4" to 1"	5	5/30	777701130113	30.77
13012	1 1/4" to 2"	2	2/20	777701130120	37.45

PRESS-FIT VALVE O-RINGS

These items are only sold in multiples of TEN (10), which is equal to one inner pack.

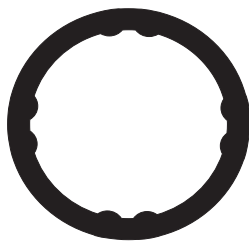

PRF RUBBER O-RING					
BMI#	Size	Min. Qty	Packing	Barcode	\$
13544	1/2	10	10/400	777701135446	8.21
13545	3/4	10	10/300	777701135453	8.21
13546	1	10	10/200	777701135460	9.67
13547	1 1/4	10	10/150	777701135477	9.67
13548	1 1/2	10	10/100	777701135484	13.66
13549	2	10	10/80	777701135491	13.66